

STRAIGHT PERSPECTIVE

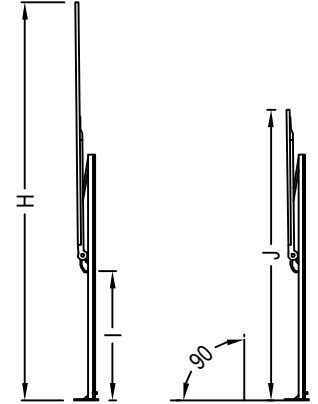

STRAIGHT POSITIONS

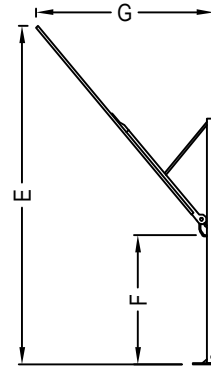
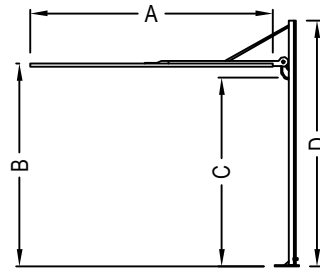
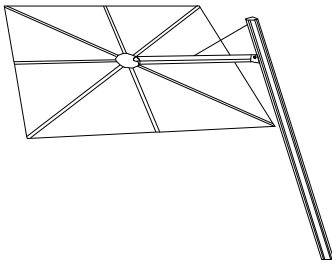

FORWARD PERSPECTIVE

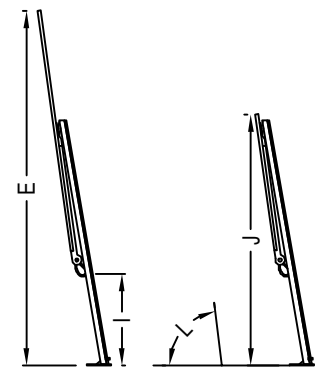
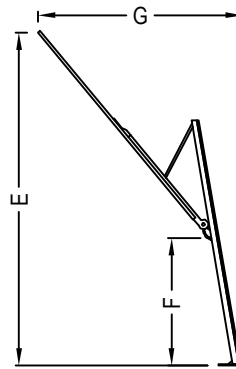
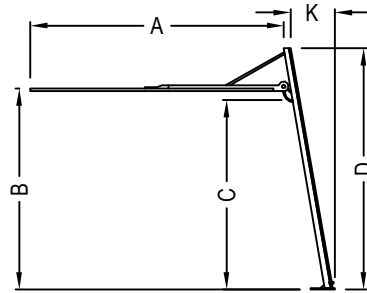

FORWARD POSITIONS

	A	B	C	D	E	F	G	H	I	J	K	L
SPECTRA S25	cm / ft	cm / ft	cm / ft	cm / ft	cm / ft	cm / ft	cm / ft	cm / ft	cm / ft	cm / ft	cm / ft	
STRAIGHT	250 / 8' 2"	206 / 6' 9"	195 / 6' 5"	260 / 8' 6"	340 / 11' 2"	150 / 4' 11"	190 / 6' 3"	375 / 12' 4"	100 / 3' 3"	270 / 8' 10"	N/A	90°
FORWARD	250 / 8' 2"	201 / 6' 7"	185 / 6' 1"	254 / 8' 4"	340 / 11' 2"	150 / 4' 11"	230 / 7' 7"	365 / 12'	100 / 3' 3"	260 / 8' 6"	65 / 2' 2"	80°

NOTES:

1. INSTALLATION TO BE COMPLETED IN ACCORDANCE WITH MANUFACTURER'S SPECIFICATIONS.
2. ALL IMPERIAL DIMENSIONS ARE METRIC CONVERSIONS AND HAVE BEEN ROUNDED TO THE NEAREST 1". IF EXACT DIMENSIONS ARE REQUIRED, SEE THE UMBROSA METRIC DIMENSIONS.
3. DO NOT SCALE DRAWING.
4. THIS DRAWING IS INTENDED FOR USE BY ARCHITECTS, ENGINEERS, CONTRACTORS, CONSULTANTS AND DESIGN PROFESSIONALS FOR PLANNING PURPOSES ONLY. THIS DRAWING MAY NOT BE USED FOR CONSTRUCTION.
5. ALL INFORMATION CONTAINED HEREIN WAS CURRENT AT THE TIME OF DEVELOPMENT BUT MUST BE REVIEWED AND APPROVED BY THE PRODUCT MANUFACTURER TO BE CONSIDERED ACCURATE.

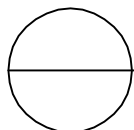

SPECTRA (OFFSET)

SOLO SQUARE STRAIGHT/FORWARD S25